

Article number: 206532M415NI
Description: E+G Knurled screw
GN 653.2-M4-15-NI

Measures

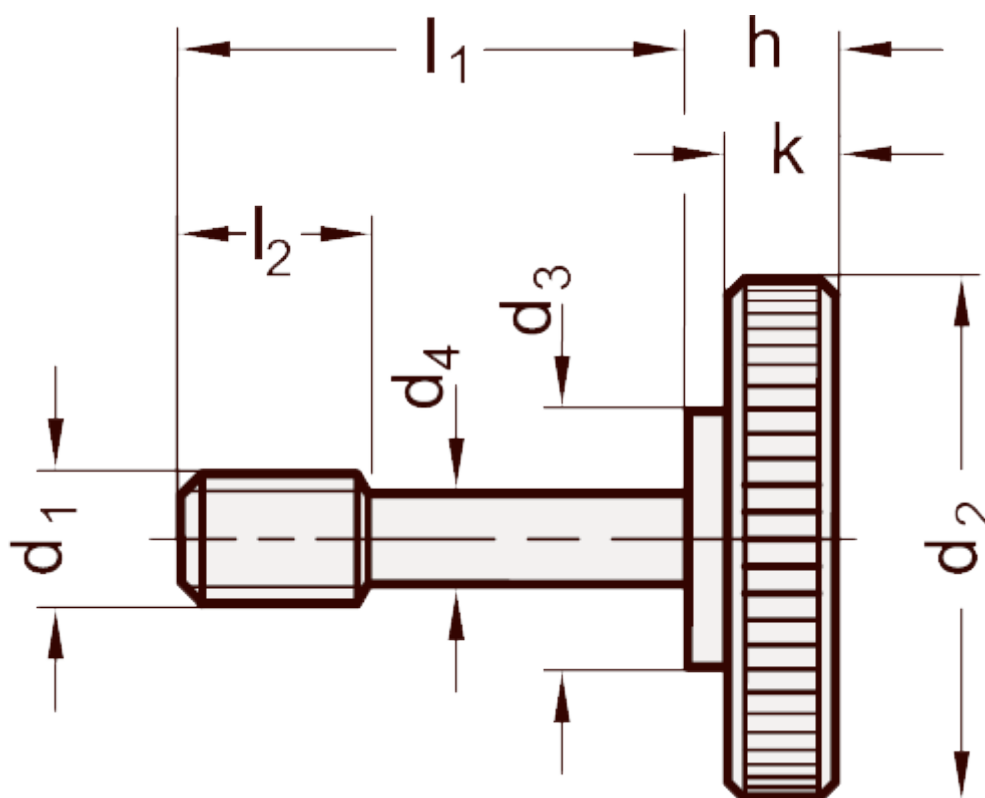

$a_1 = 2-4$	$h = 5.5$
$a_2 = 4-8$	$k = 3.5$
$a_3 = 8-10$	$l_2 = 5$
$d_1 = M4$	Weight in (g) = 6
$d_2 = 16$	
$d_3 = 8$	
$d_4 = 3.2$	
$d_5 = 4.5$	